

0 611 215 703

Issue } 03-06-17
Stand }

Fig./Abb. 2

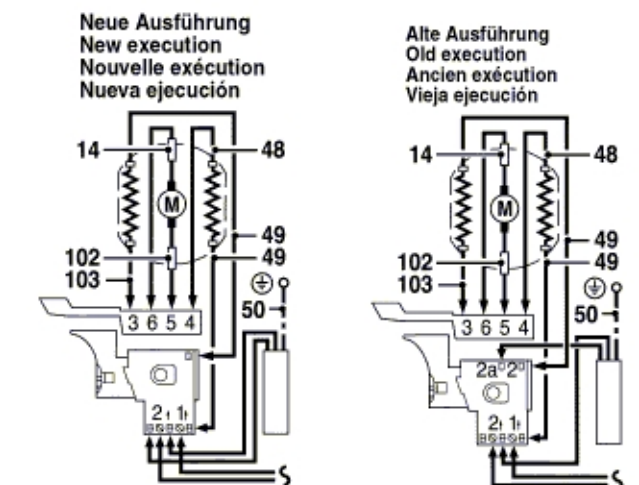
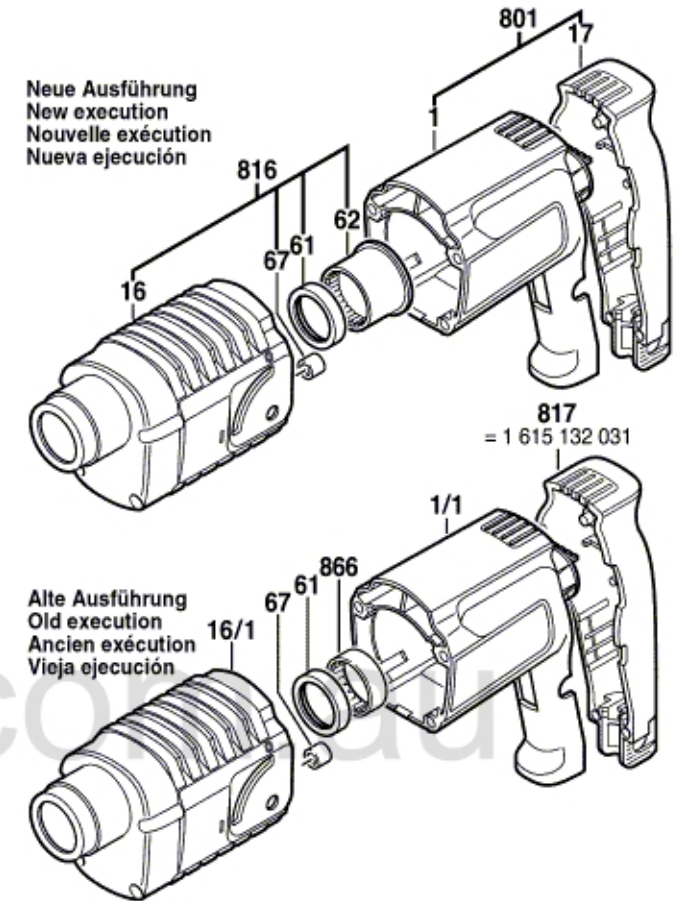
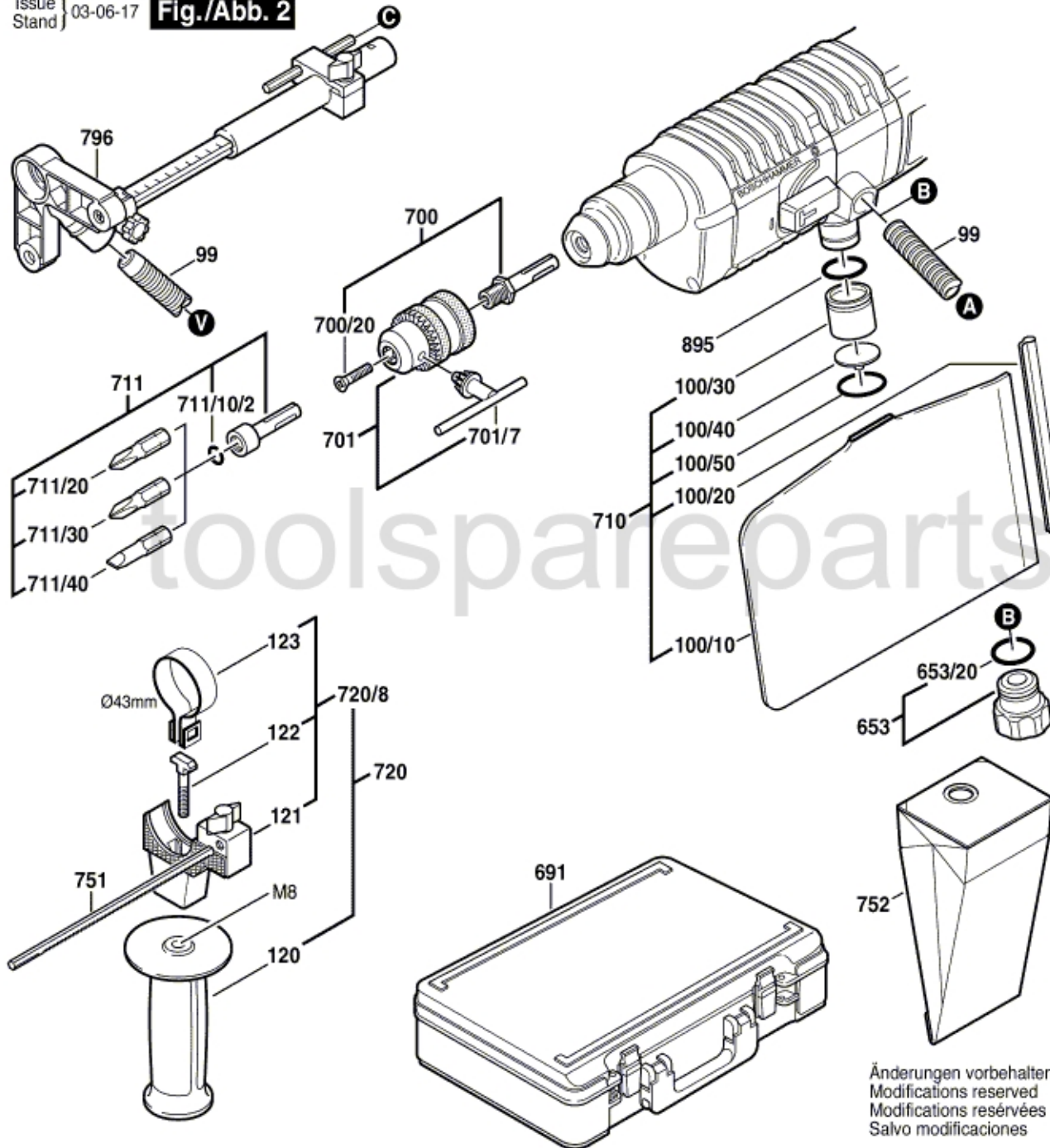

Änderungen vorbehalten
Modifications reserved
Modifications réservées
Salvo modificaciones